

Cascadable Silicon Bipolar MMIC Amplifiers

Technical Data

MSA-0735, -0736

Features

- **Cascadable 50 Ω Gain Block**
- **Low Operating Voltage:**
4.0 V Typical V_d
- **3 dB Bandwidth:**
DC to 2.4 GHz
- **13.0 dB Typical Gain at 1.0 GHz**
- **Unconditionally Stable ($k > 1$)**
- **Cost Effective Ceramic Microstrip Package**

Description

The MSA-0735 is a high performance silicon bipolar Monolithic Microwave Integrated Circuit (MMIC) housed in a cost effective,

microstrip package. This MMIC is designed for use as a general purpose 50 Ω gain block. Typical applications include narrow and broad band IF and RF amplifiers in industrial and military applications.

The MSA-series is fabricated using HP's 10 GHz f_T , 25 GHz f_{MAX} , silicon bipolar MMIC process which uses nitride self-alignment, ion implantation, and gold metallization to achieve excellent performance, uniformity and reliability. The use of an external bias resistor for temperature and current stability also allows bias flexibility.

35 micro-X Package^[1]

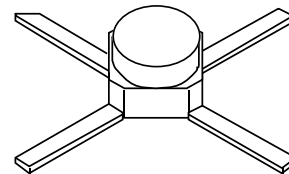

Note:

1. Short leaded 36 package available upon request.

Typical Biasing Configuration

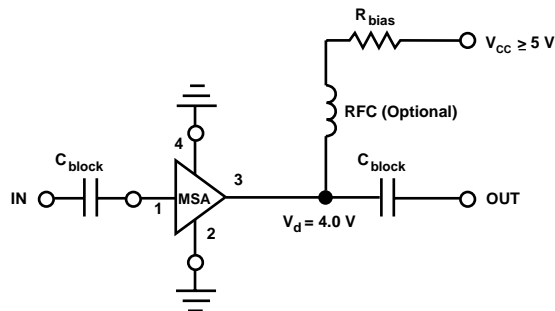

MSA-0735, -0736 Absolute Maximum Ratings

Parameter	Absolute Maximum ^[1]
Device Current	60 mA
Power Dissipation ^[2,3]	275 mW
RF Input Power	+13 dBm
Junction Temperature	200°C
Storage Temperature	-65 to 200°C

Thermal Resistance^[2,5]:

$$\theta_{jc} = 155^{\circ}\text{C/W}$$

Notes:

1. Permanent damage may occur if any of these limits are exceeded.
2. $T_{\text{CASE}} = 25^{\circ}\text{C}$.
3. Derate at 6.5 mW/°C for $T_{\text{C}} > 157^{\circ}\text{C}$.
4. Storage above +150°C may tarnish the leads of this package making it difficult to solder into a circuit.
5. This small spot size of this technique results in a higher, though more accurate determination of θ_{jc} than do alternate methods. See MEASUREMENTS section "Thermal Resistance" for more information.

Electrical Specifications^[1], $T_{\text{A}} = 25^{\circ}\text{C}$

Symbol	Parameters and Test Conditions: $I_{\text{d}} = 22 \text{ mA}$, $Z_{\text{O}} = 50 \Omega$	Units	Min.	Typ.	Max.
G_{P}	Power Gain ($ S_{21} ^2$) $f = 0.1 \text{ GHz}$	dB	12.5	13.5	14.5
ΔG_{P}	Gain Flatness $f = 0.1 \text{ to } 1.3 \text{ GHz}$	dB		± 0.6	± 1.0
$f_{3 \text{ dB}}$	3 dB Bandwidth	GHz		2.4	
VSWR	Input VSWR $f = 0.1 \text{ to } 2.5 \text{ GHz}$			2.0:1	
	Output VSWR $f = 0.1 \text{ to } 2.5 \text{ GHz}$			1.8:1	
NF	50 Ω Noise Figure $f = 1.0 \text{ GHz}$	dB		4.5	
$P_{1 \text{ dB}}$	Output Power at 1 dB Gain Compression $f = 1.0 \text{ GHz}$	dBm		5.5	
IP_3	Third Order Intercept Point $f = 1.0 \text{ GHz}$	dBm		19.0	
t_{D}	Group Delay $f = 1.0 \text{ GHz}$	psec		140	
V_{d}	Device Voltage	V	3.6	4.0	4.4
dV/dT	Device Voltage Temperature Coefficient	mV/°C		-7.0	

Note:

1. The recommended operating current range for this device is 15 to 40 mA. Typical performance as a function of current is on the following page.

Part Number Ordering Information

Part Number	No. of Devices	Container
MSA-0735	10	Strip
MSA-0736-BLK	100	Antistatic Bag
MSA-0736-TR1	1000	7" Reel

For more information, see "Tape and Reel Packaging for Semiconductor Devices".

MSA-0735, -0736 Typical Scattering Parameters ($Z_0 = 50 \Omega$, $T_A = 25^\circ\text{C}$, $I_d = 22 \text{ mA}$)

Freq. GHz	S ₁₁		S ₂₁			S ₁₂			S ₂₂	
	Mag	Ang	dB	Mag	Ang	dB	Mag	Ang	Mag	Ang
0.1	.13	-3	13.5	4.71	175	-19.0	.112	2	.29	-7
0.2	.13	-6	13.4	4.69	170	-18.5	.119	3	.29	-12
0.4	.14	-13	13.4	4.68	160	-18.6	.118	6	.29	-24
0.6	.16	-20	13.3	4.64	150	-18.4	.120	7	.28	-35
0.8	.19	-29	13.2	4.60	140	-18.1	.125	8	.28	-47
1.0	.21	-40	12.9	4.42	129	-17.6	.131	10	.27	-58
1.5	.27	-71	12.2	4.07	104	-16.5	.149	10	.24	-83
2.0	.32	-107	11.5	3.74	79	-15.6	.165	7	.19	-103
2.5	.37	-134	10.3	3.26	62	-15.3	.173	5	.15	-113
3.0	.43	-160	8.8	2.76	44	-15.4	.171	0	.14	-120
3.5	.47	-179	7.5	2.37	27	-15.3	.173	-4	.16	-120
4.0	.49	167	6.2	2.05	12	-15.2	.168	-6	.21	-121
5.0	.51	134	4.0	1.59	-15	-15.2	.173	-11	.28	-135
6.0	.60	96	2.1	1.27	-42	-14.6	.185	-16	.29	-167

A model for this device is available in the DEVICE MODELS section.

Typical Performance, $T_A = 25^\circ\text{C}$

(unless otherwise noted)

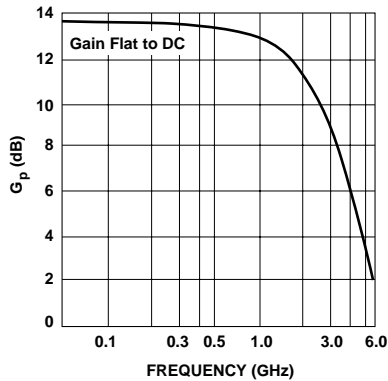

Figure 1. Typical Power Gain vs. Frequency, $I_d = 22 \text{ mA}$.

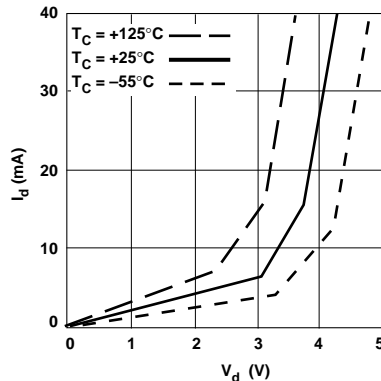

Figure 2. Device Current vs. Voltage.

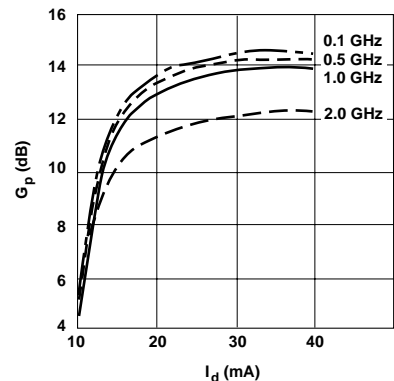

Figure 3. Power Gain vs. Current.

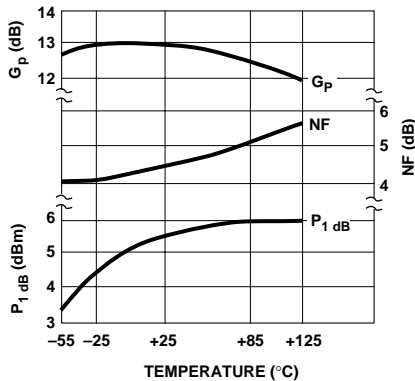

Figure 4. Output Power at 1 dB Gain Compression, NF and Power Gain vs. Case Temperature, $f = 1.0 \text{ GHz}$, $I_d = 22 \text{ mA}$.

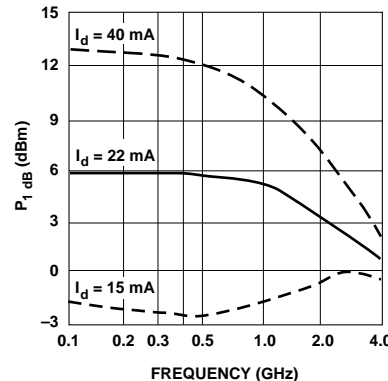

Figure 5. Output Power at 1 dB Gain Compression vs. Frequency.

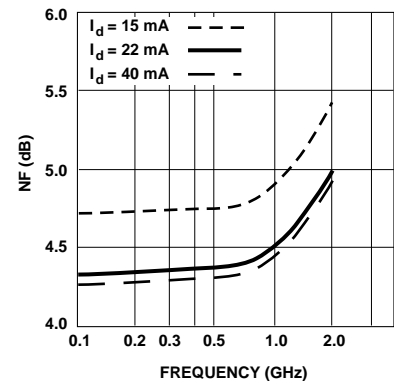

Figure 6. Noise Figure vs. Frequency.

35 micro-X Package Dimensions

